

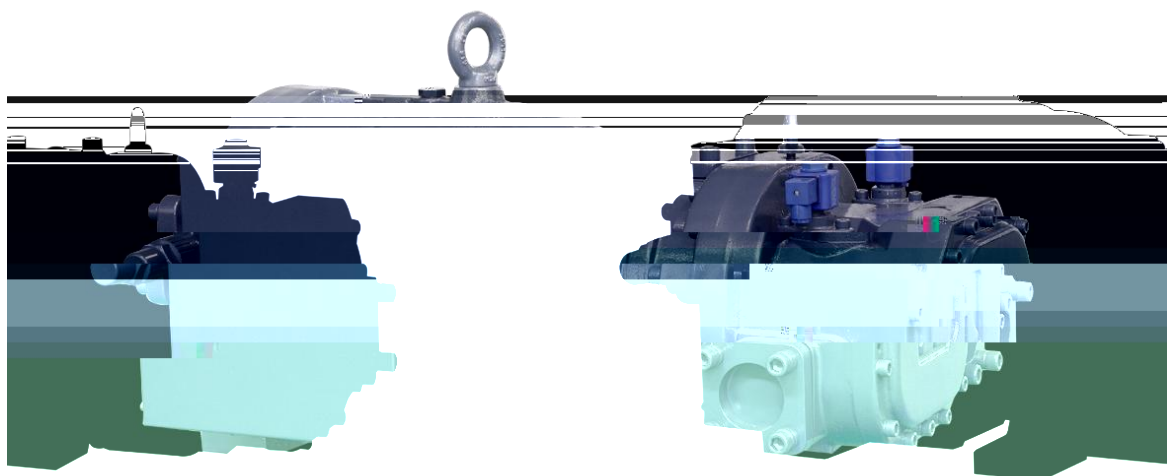

RH 'Ì- (v5>-¬; -À@Z@Z< 0







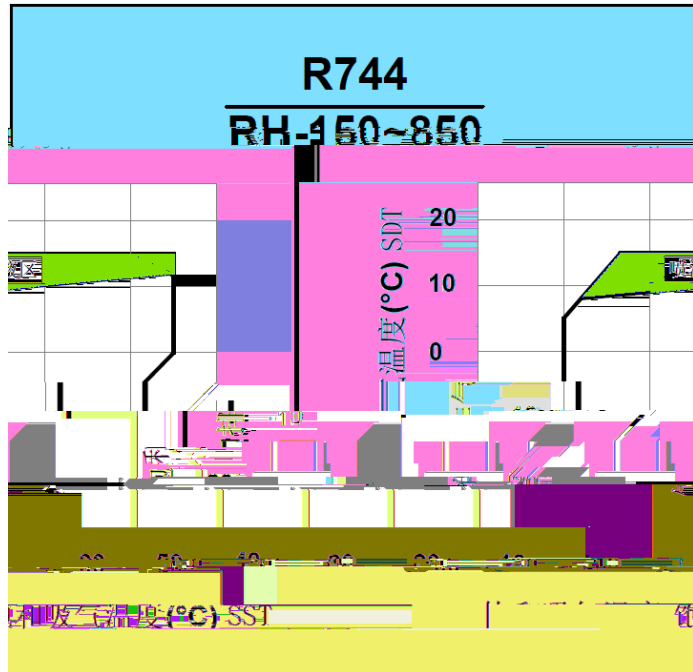



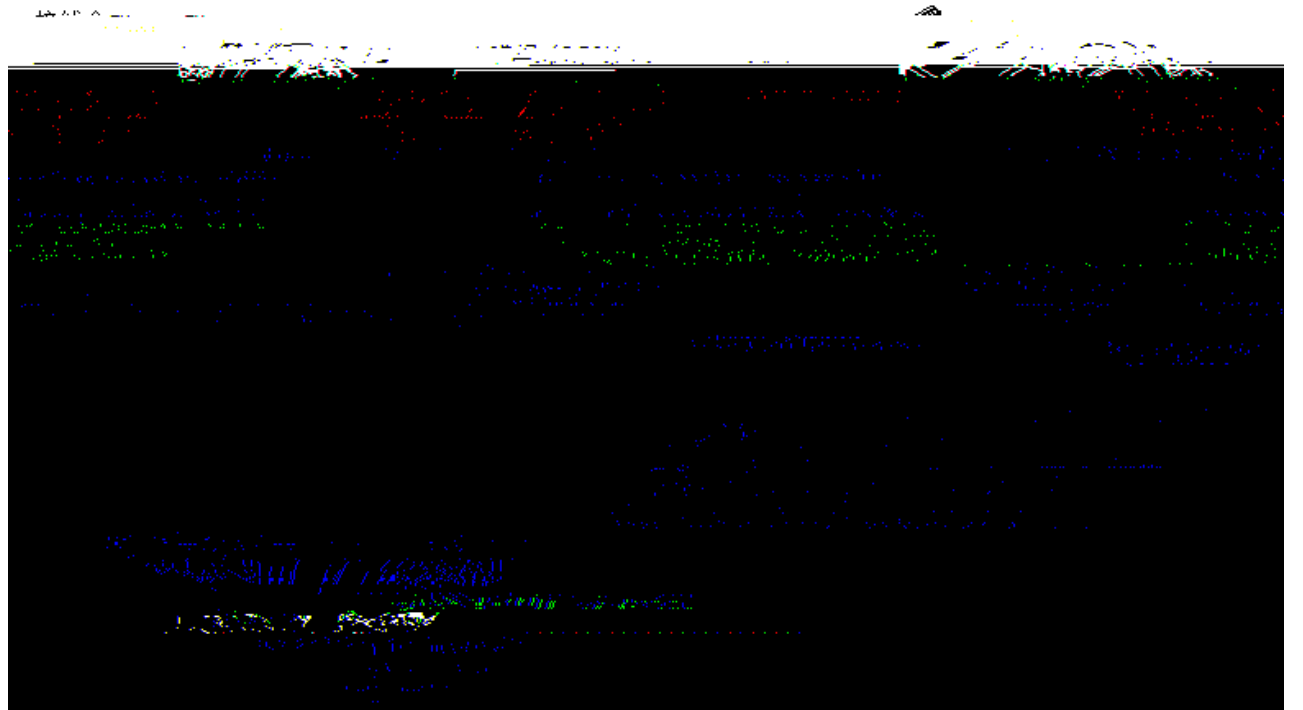
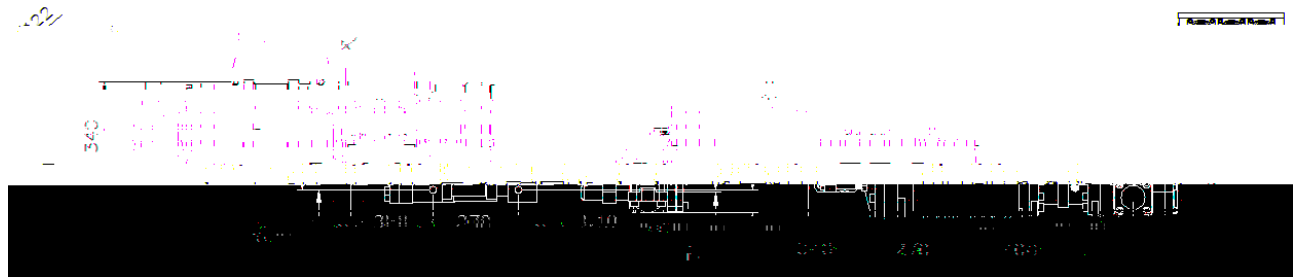
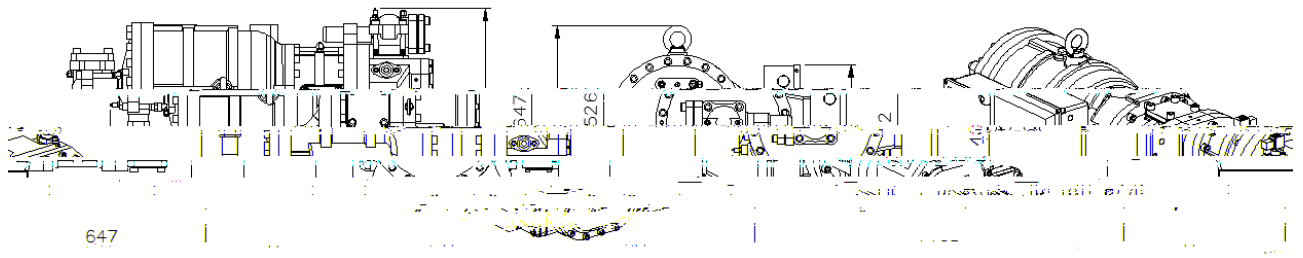



B-?±,x> =]

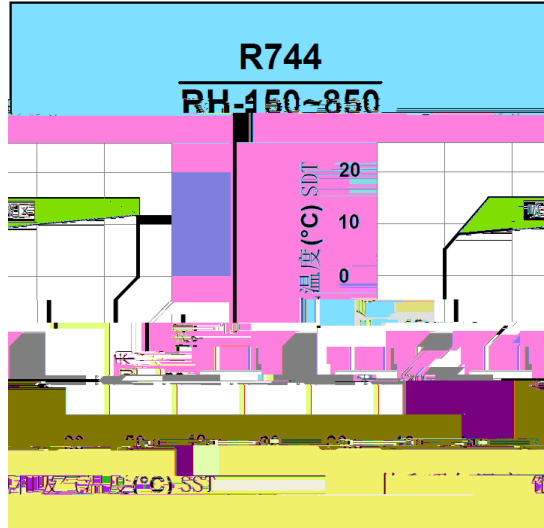

.z=™=™D



.z,p> ?;

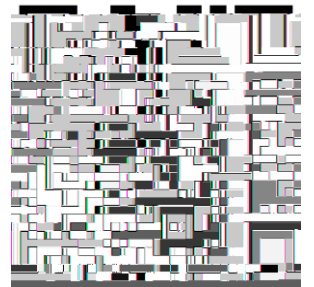

+^D0@š(_



@#-%XJN2ô •6× 3 ?L† Ç .

SHANGHAI HANBELL PRECISE MACHINERY CO.,LTD >

+yD 0:p/ ;11'^^9 - N C"=E- .L5 8289&

TEL 021-57350280 FAX 021-51368588

Ò = C4i Ò 4007702158

FP5F 0201501

http 0//www.hanbell.com.cn

0=6°,+L;ß

+yD 00=6°;1)A9 9 B 9 5 6°/ 2222/&4K, U .;0x8TA -¼ 4/&5
+^/N É TEI 0531-85060075 *CEC† FAX 0531-85060071

6°2 ,+L;ß

+yD 06°2 ;11N689 2E,Ä9 -,AA5 1001/&4K, U .;0x8TA -¼ 6,
+^/N É TEI 025--52078091/1/3 *CEC† FAX 025-52078090

„D>,+L;ß

„D>;1,E•9 ; 0 C*>%(€*Æ>%205 4K=>EA B' 15 /&)E.à
+^/N É TEI 020-34721075 *CEC† FAX 020-3472325

D99 ,+L;ß

D99 ;16°—9)IB?E9 B 5N5 18 /&6» F 9S5 1-1

+^/N É TEI 023-62611068 *CEC† FAX 023-62611069